

- Low Power Consumption
- Wide Common-Mode and Differential Voltage Ranges
- Low Input Bias and Offset Currents
- Output Short-Circuit Protection
- Low Total Harmonic Distortion . . . 0.003% Typ
- High Input Impedance . . . JFET Input Stage
- External Frequency Compensation
- Common-Mode Input Voltage Range Includes V_{CC+}
- Latch-Up-Free Operation
- High Slew Rate . . . 13 V/ μ s Typ

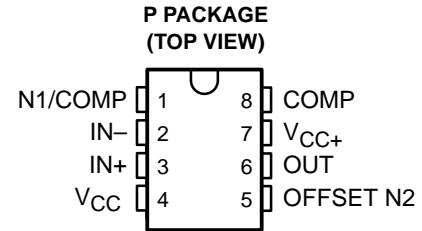

description

The TL080 JFET-input operational amplifier incorporates well-matched, high-voltage JFET and bipolar transistors in an integrated circuit. This device features high slew rates, low input bias and offset currents, and a low offset-voltage temperature coefficient. Offset adjustment and external-compensation options are available.

The TL080C is characterized for operation from 0°C to 70°C.

AVAILABLE OPTIONS

T _A	V _{IOMax} AT 25°C	PACKAGE
		PLASTIC DIP (P)
0°C to 70°C	10 mV	TL080CP



Please be aware that an important notice concerning availability, standard warranty, and use in critical applications of Texas Instruments semiconductor products and disclaimers thereto appears at the end of this data sheet.

PRODUCTION DATA information is current as of publication date. Products conform to specifications per the terms of Texas Instruments standard warranty. Production processing does not necessarily include testing of all parameters.

**TEXAS
INSTRUMENTS**

POST OFFICE BOX 655303 • DALLAS, TEXAS 75265

Copyright © 2001, Texas Instruments Incorporated

TL080 JFET-INPUT OPERATIONAL AMPLIFIER

SLOS368 – JUNE 2001

schematic

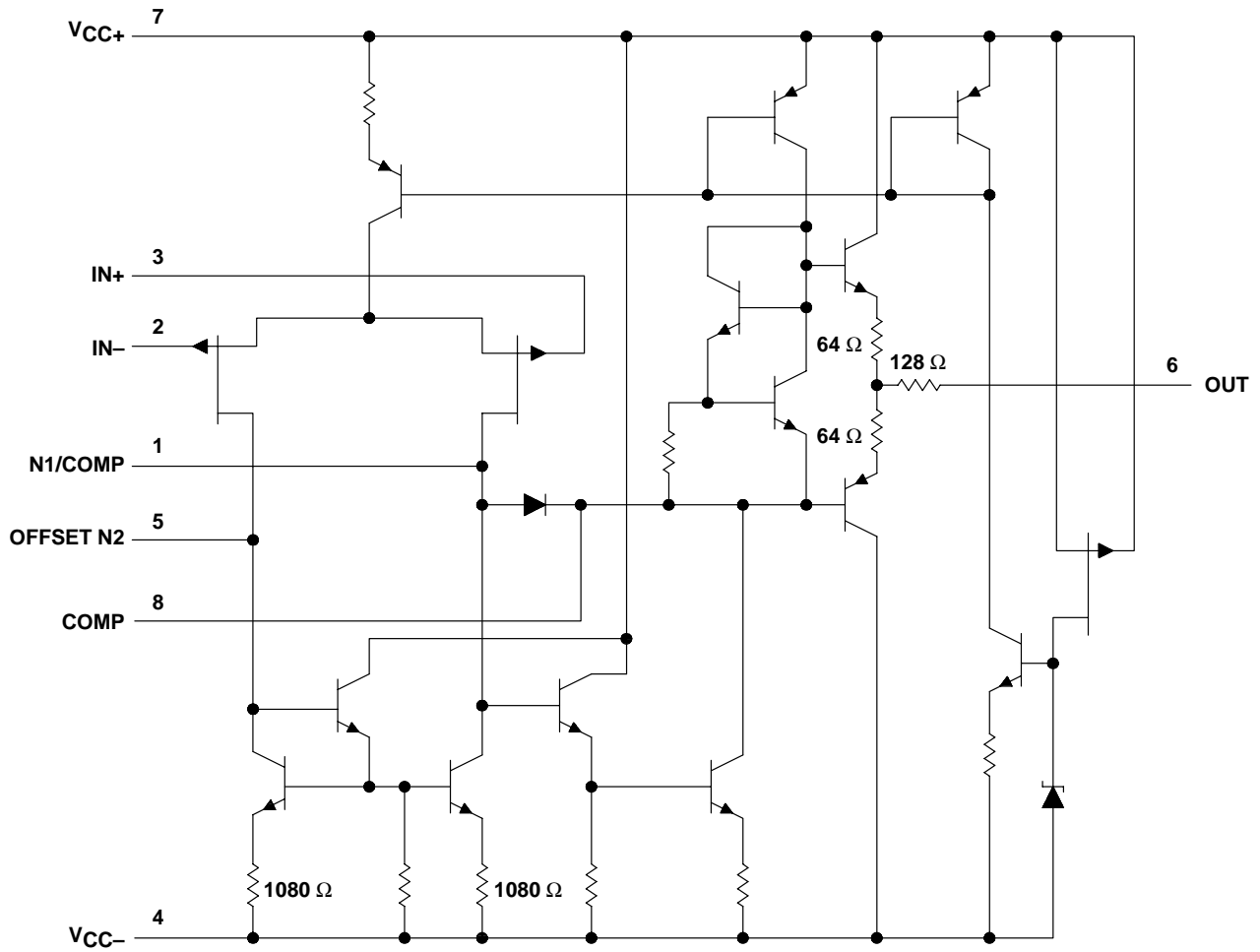

All component values shown are nominal.

absolute maximum ratings over operating free-air temperature range (unless otherwise noted)†

Supply voltage (see Note 1): V_{CC+}	18 V
V_{CC-}	–18 V
Differential input voltage, V_{ID} (see Note 2)	±30 V
Input voltage, V_I (see Notes 1 and 3)	±15 V
Duration of short-circuit current (see Note 4)	Unlimited
Package thermal impedance, θ_{JA} (see Notes 5 and 6)	85°C/W
Lead temperature 1,6 mm (1/16 inch) from case for 10 seconds	260°C
Storage temperature range, T_{stg}	–65°C to 150°C

† Stresses beyond those listed under “absolute maximum ratings” may cause permanent damage to the device. These are stress ratings only, and functional operation of the device at these or any other conditions beyond those indicated under “recommended operating conditions” is not implied. Exposure to absolute-maximum-rated conditions for extended periods may affect device reliability.

- NOTES:
1. All voltage values, except differential voltages, are with respect to the midpoint between V_{CC+} and V_{CC-} .
 2. Differential voltages are at $IN+$ with respect to $IN-$.
 3. The magnitude of the input voltage must never exceed the magnitude of the supply voltage or 15 V, whichever is less.
 4. The output can be shorted to ground or to either supply. Temperature and/or supply voltages must be limited to ensure that the dissipation rating is not exceeded.
 5. Maximum power dissipation is a function of $T_J(max)$, θ_{JA} , and T_A . The maximum allowable power dissipation at any allowable ambient temperature is $P_D = (T_J(max) - T_A)/\theta_{JA}$. Operating at the absolute maximum T_J of 150°C can impact reliability.
 6. The package thermal impedance is calculated in accordance with JESD 51-7.

electrical characteristics, $V_{CC\pm} = \pm 15$ V (unless otherwise noted)

PARAMETER		TEST CONDITIONS	T_A †	MIN	TYP	MAX	UNIT
V_{IO}	Input offset voltage	$V_O = 0, R_S = 50 \Omega$	25°C		3	15	mV
			Full range			20	
$\alpha_{V_{IO}}$	Temperature coefficient of input offset voltage	$V_O = 0, R_S = 50 \Omega$	Full range		18		$\mu V/^\circ C$
I_{IO}	Input offset current‡	$V_O = 0$	25°C		5	200	pA
			Full range			2	nA
I_{IB}	Input bias current‡	$V_O = 0$	25°C		30	400	pA
			Full range			10	nA
V_{ICR}	Common-mode input voltage range		25°C	±11	–12 to 15		V
V_{OM}	Maximum peak output voltage swing	$R_L = 10 k\Omega$	25°C	±12	±13.5		V
		$R_L \geq 10 k\Omega$	Full range	±12			
		$R_L \geq 2 k\Omega$		±10		±12	
A_{VD}	Large-signal differential voltage amplification	$V_O = \pm 10$ V, $R_L \geq 2 k\Omega$	25°C	25	200		V/mV
			Full range	15			
B_1	Unity-gain bandwidth		25°C		3		MHz
r_i	Input resistance		25°C		10^{12}		Ω
CMRR	Common-mode rejection ratio	$V_{IC} = V_{ICRmin}, V_O = 0, R_S = 50 \Omega$	25°C	70	86		dB
k_{SVR}	Supply-voltage rejection ratio ($\Delta V_{CC\pm}/\Delta V_{IO}$)	$V_{CC} = \pm 15$ V to ± 9 V, $V_O = 0, R_S = 50 \Omega$	25°C	70	86		dB
I_{CC}	Supply current	$V_O = 0, \text{ No load}$	25°C		1.4	2.8	mA
V_{O1}/V_{O2}	Crosstalk attenuation	$A_{VD} = 100$	25°C		120		dB

† All characteristics are measured under open-loop conditions with zero common-mode voltage unless otherwise specified. Full range for T_A is –40°C to 85°C.

‡ Input bias currents of a FET-input operational amplifier are normal junction reverse currents, which are temperature sensitive, as shown in Figure 5. Pulse techniques must be used that will maintain the junction temperature as close to the ambient temperature as possible.

TL080 JFET-INPUT OPERATIONAL AMPLIFIER

SLOS368 – JUNE 2001

operating characteristics, $V_{CC\pm} = \pm 15\text{ V}$, $T_A = 25^\circ\text{C}$

PARAMETER	TEST CONDITIONS			MIN	TYP	MAX	UNIT
SR Slew rate at unity gain	$V_I = 10\text{ V}$,	$R_L = 2\text{ k}\Omega$,	$C_L = 100\text{ pF}$, See Figure 1	8	13		$\text{V}/\mu\text{s}$
t_r Rise-time overshoot factor	$V_I = 20\text{ mV}$,	$R_L = 2\text{ k}\Omega$,	$C_L = 100\text{ pF}$, See Figure 1		0.05		μs
V_n Equivalent input noise voltage	$R_S = 100\ \Omega$	$f = 1\text{ kHz}$			18		$\text{nV}/\sqrt{\text{Hz}}$
		$f = 10\text{ Hz to } 10\text{ kHz}$			4		μV
I_n Equivalent input noise current	$R_S = 100\ \Omega$,	$f = 1\text{ kHz}$			0.01		$\text{pA}/\sqrt{\text{Hz}}$
THD Total harmonic distortion	$V_{O(\text{rms})} = 10\text{ V}$,	$R_S \leq 1\text{ k}\Omega$,	$R_L \geq 2\text{ k}\Omega$, $f = 1\text{ kHz}$		0.003%		

APPLICATION INFORMATION

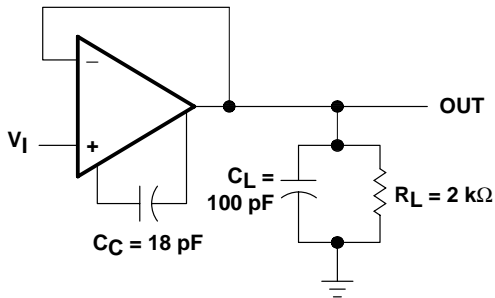

Figure 1. Unity-Gain Amplifier

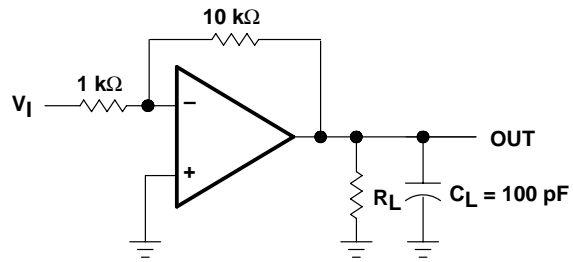

Figure 2. Gain-of-10 Inverting Amplifier

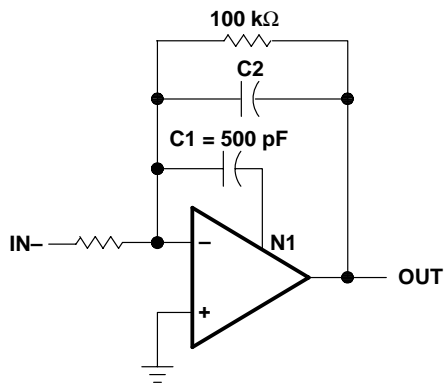

Figure 3. Feed-Forward Compensation

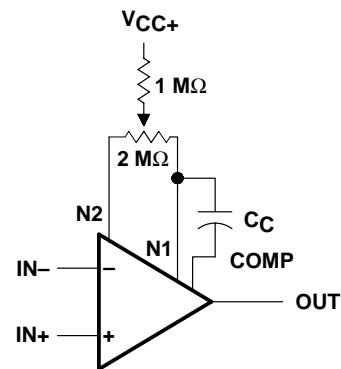

Figure 4. Input Offset Voltage Null Circuit

TYPICAL CHARACTERISTICS

Table of Graphs

		FIGURE	
V_{OM}	Maximum peak output voltage	vs Frequency	5, 6, 7
		vs Free-air temperature	8
		vs Load resistance	9
		vs Supply voltage	10
A_{VD}	Large-signal differential voltage amplification	vs Free-air temperature	11
		vs Frequency	12
	Differential voltage amplification	vs Frequency	13
P_D	Total power dissipation	vs Free-air temperature	14
I_{CC}	Supply current	vs Free-air temperature	14
		vs Supply voltage	15
I_{IB}	Input bias current	vs Free-air temperature	16
	Large-signal pulse response	vs Time	17
V_O	Output voltage	vs Elapsed time	18
CMRR	Common-mode rejection ratio	vs Free-air temperature	19
V_n	Equivalent input noise voltage	vs Frequency	20
THD	Total harmonic distortion	vs Frequency	21

MAXIMUM PEAK OUTPUT VOLTAGE
vs
FREQUENCY

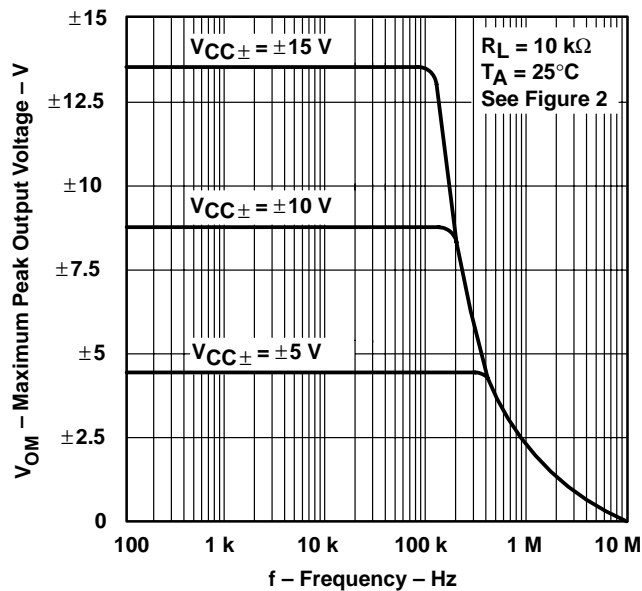

Figure 5

MAXIMUM PEAK OUTPUT VOLTAGE
vs
FREQUENCY

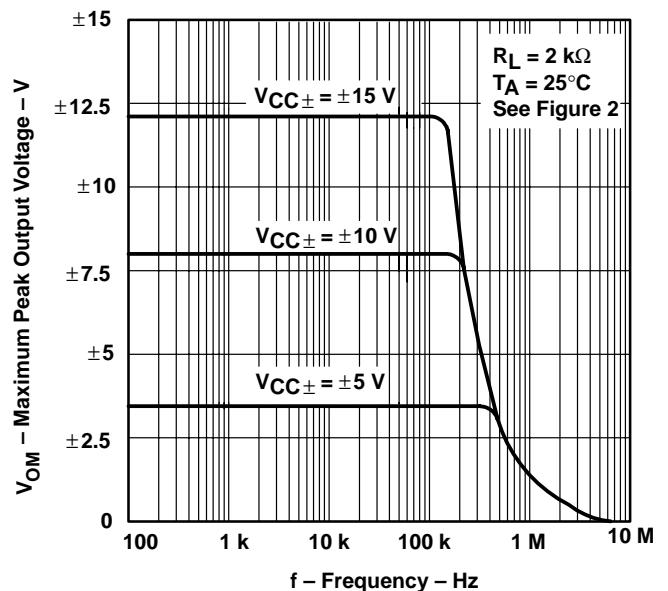

Figure 6

TYPICAL CHARACTERISTICS

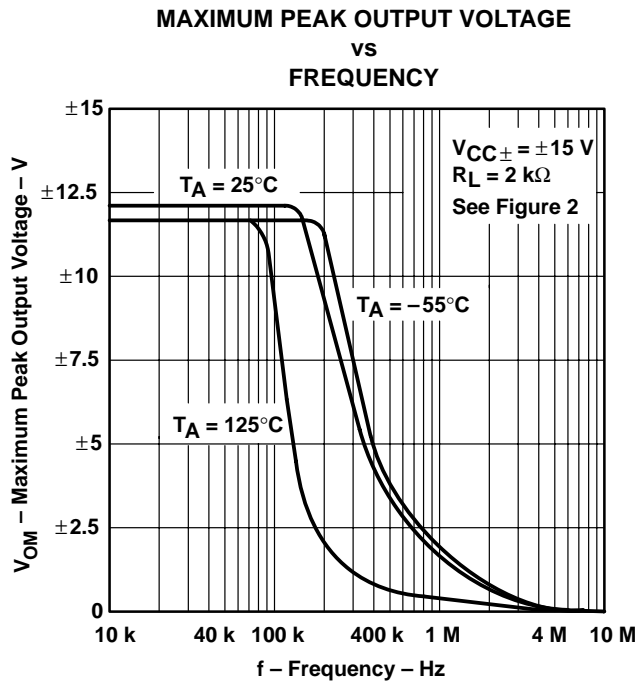

Figure 7

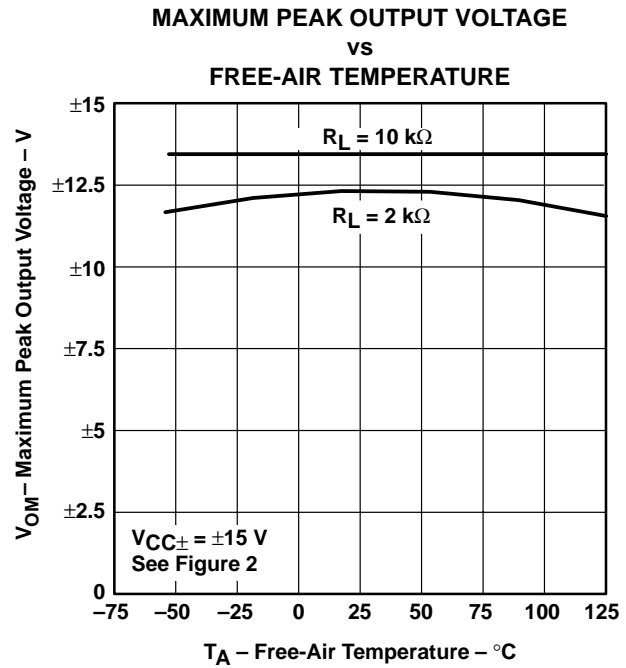

Figure 8

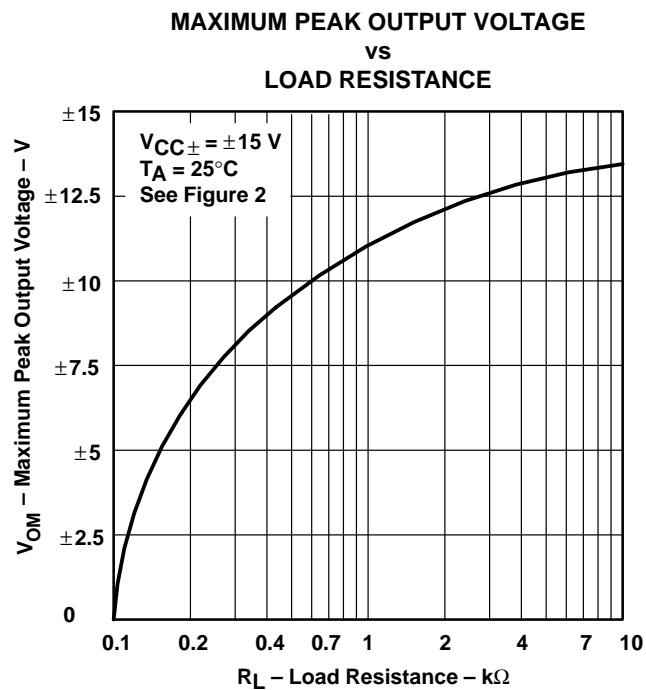

Figure 9

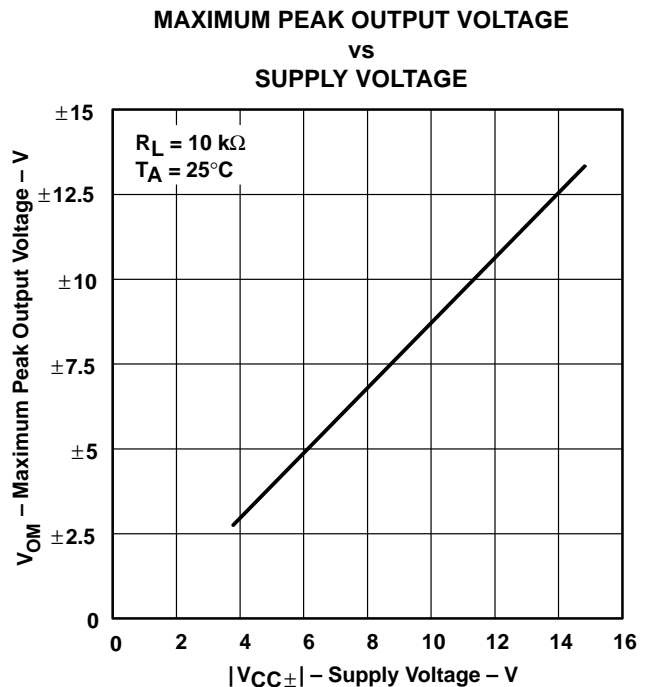
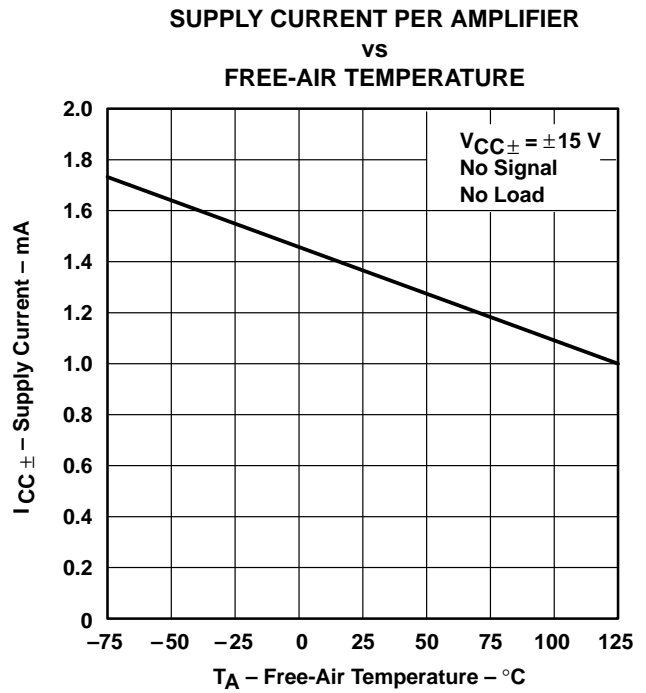
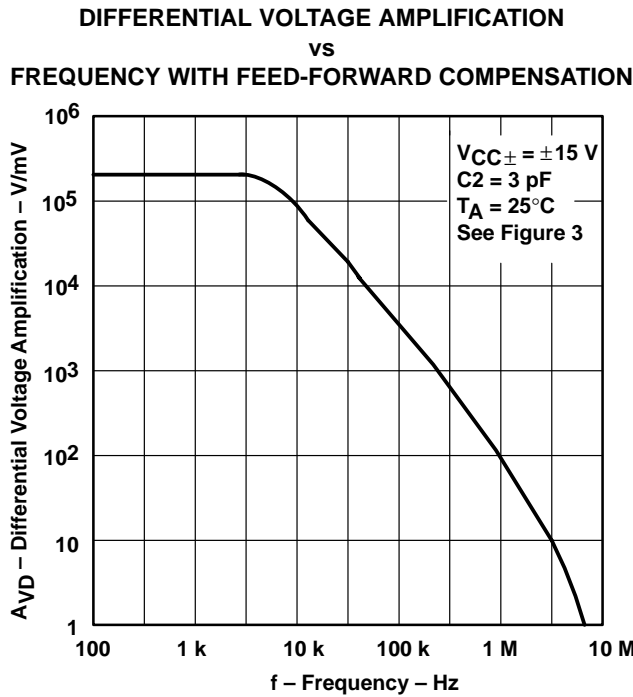
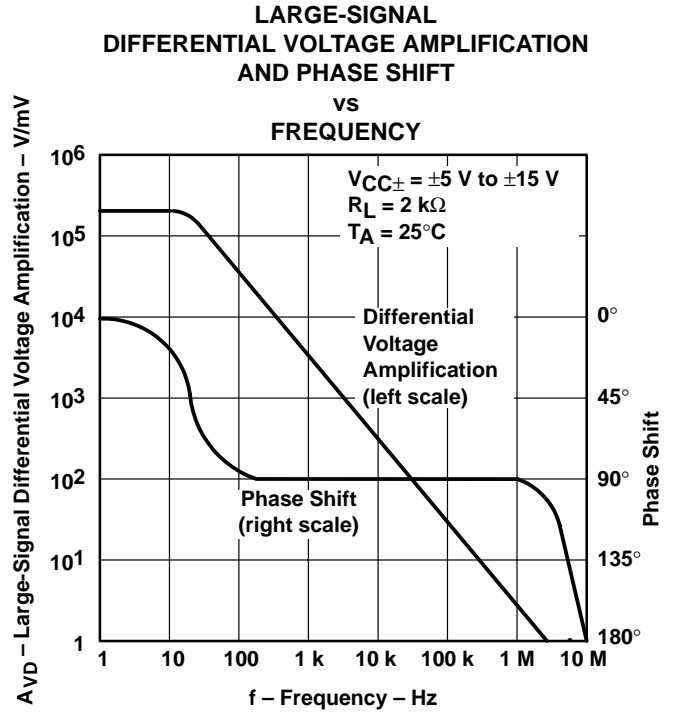
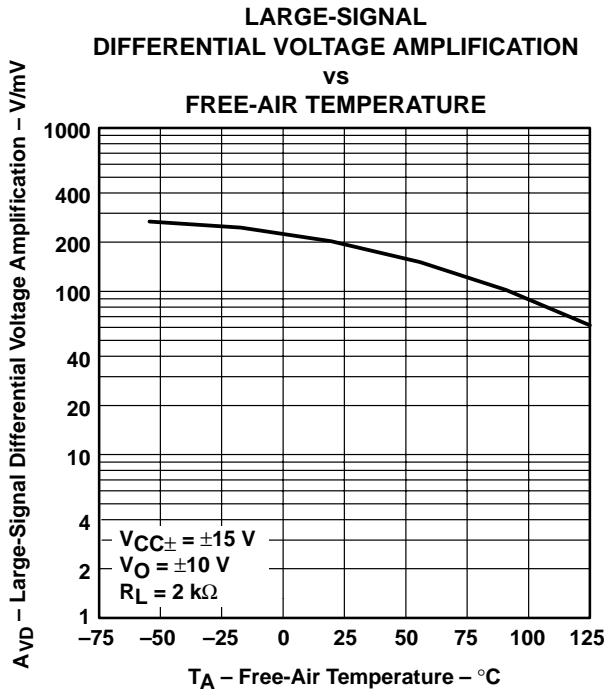

Figure 10

TYPICAL CHARACTERISTICS



TYPICAL CHARACTERISTICS

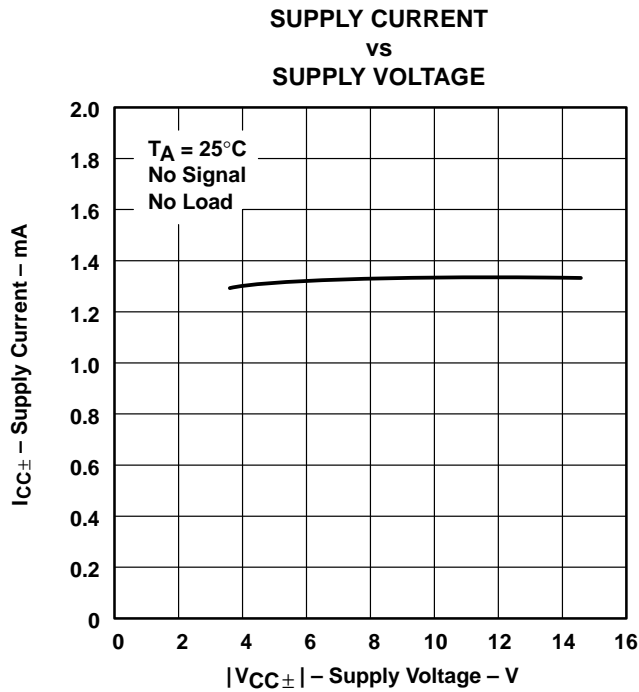

Figure 15

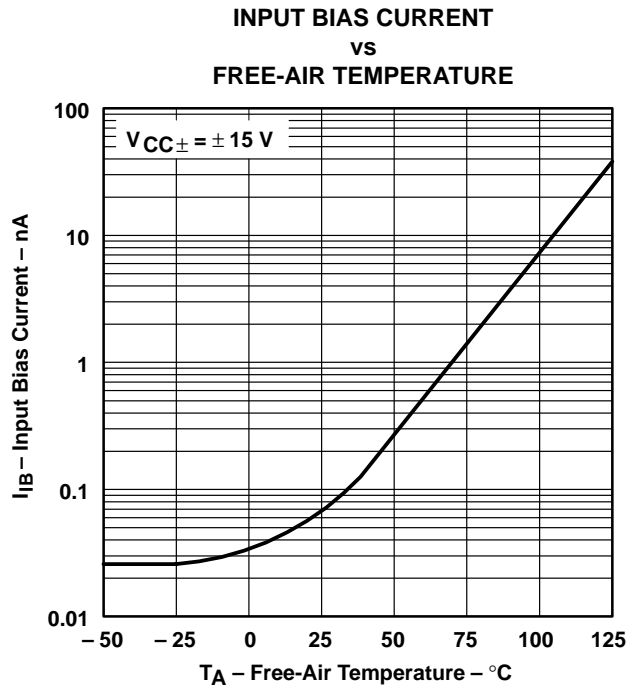

Figure 16

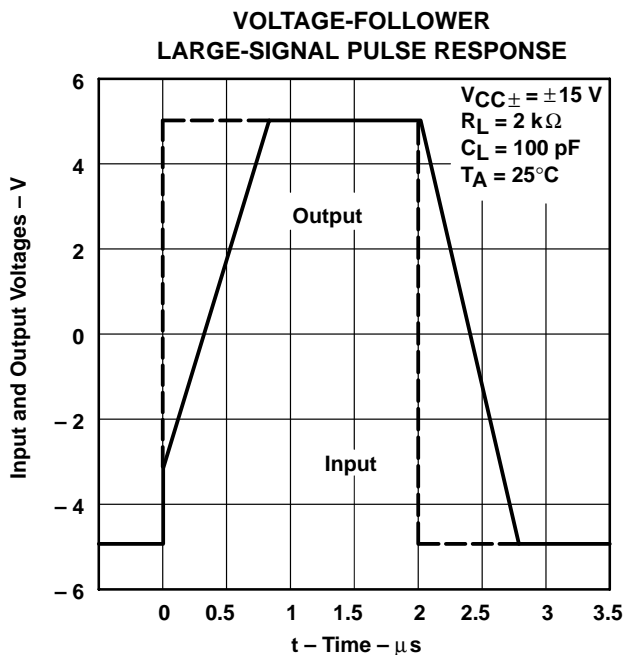

Figure 17

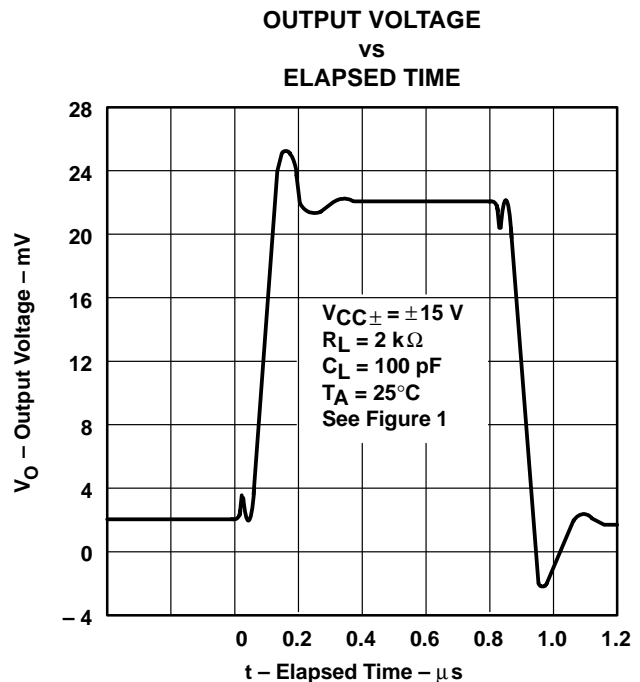

Figure 18

TYPICAL CHARACTERISTICS

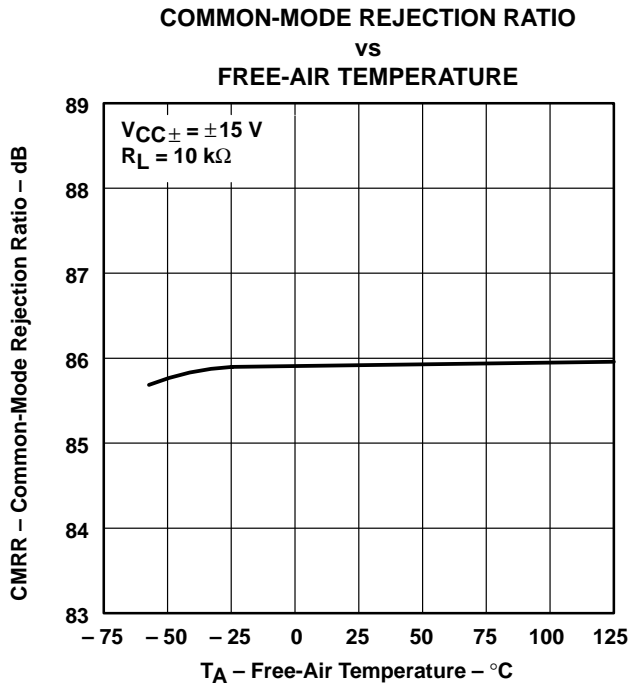

Figure 19

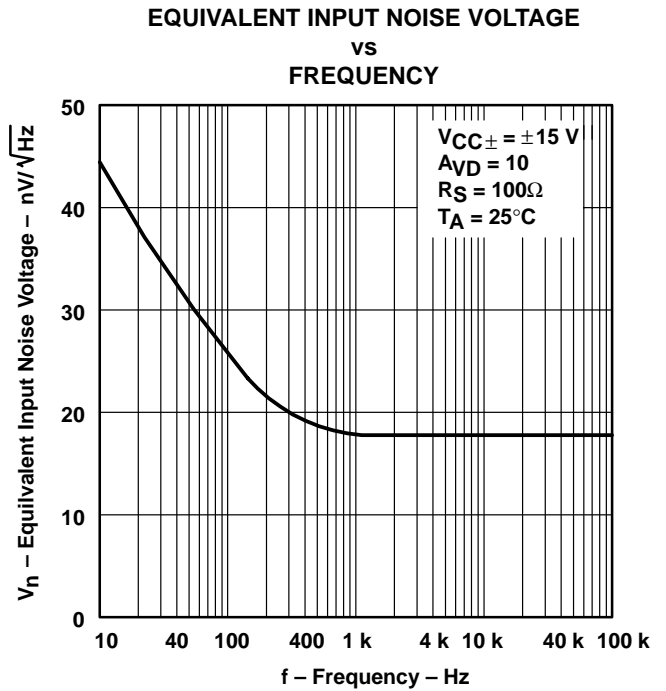

Figure 20

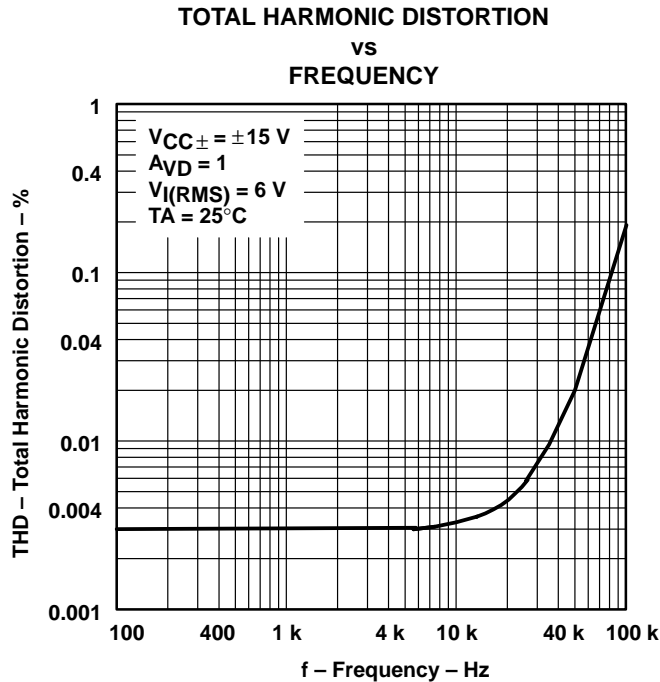

Figure 21

TL080 JFET-INPUT OPERATIONAL AMPLIFIER

SLOS368 – JUNE 2001

APPLICATION INFORMATION

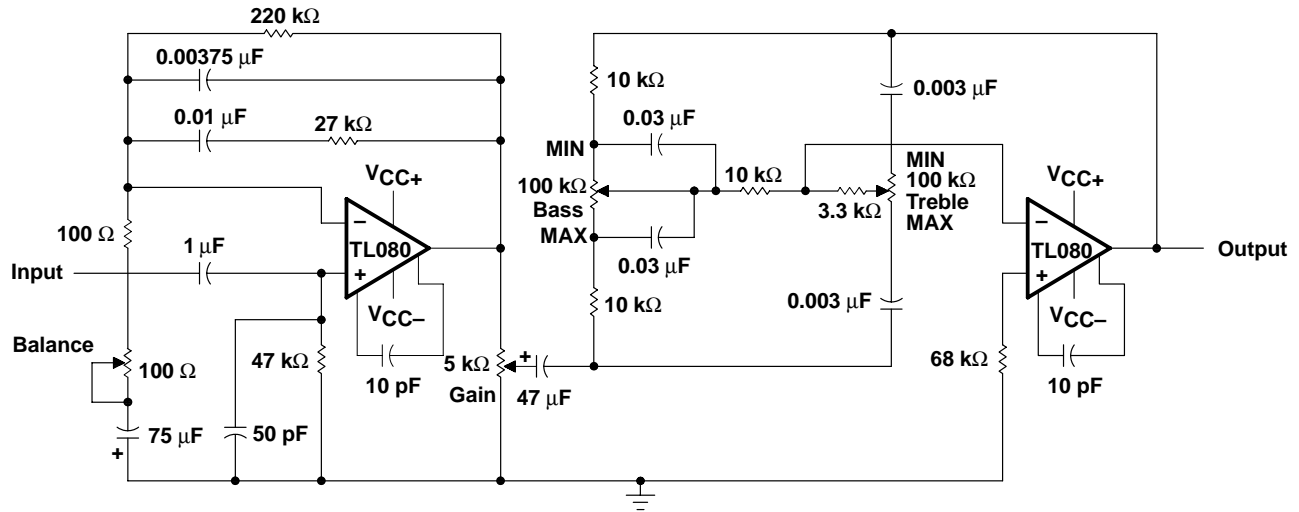

Figure 22. IC Preamplifier

PACKAGING INFORMATION

Orderable Device	Status ⁽¹⁾	Package Type	Package Drawing	Pins	Package Qty	Eco Plan ⁽²⁾	Lead/Ball Finish	MSL Peak Temp ⁽³⁾
TL080CP	ACTIVE	PDIP	P	8	50	Pb-Free (RoHS)	CU NIPDAU	N / A for Pkg Type
TL080CPE4	ACTIVE	PDIP	P	8	50	Pb-Free (RoHS)	CU NIPDAU	N / A for Pkg Type
TL080IP	OBSOLETE	PDIP	P	8		TBD	Call TI	Call TI

⁽¹⁾ The marketing status values are defined as follows:

ACTIVE: Product device recommended for new designs.

LIFEBUY: TI has announced that the device will be discontinued, and a lifetime-buy period is in effect.

NRND: Not recommended for new designs. Device is in production to support existing customers, but TI does not recommend using this part in a new design.

PREVIEW: Device has been announced but is not in production. Samples may or may not be available.

OBSOLETE: TI has discontinued the production of the device.

⁽²⁾ Eco Plan - The planned eco-friendly classification: Pb-Free (RoHS), Pb-Free (RoHS Exempt), or Green (RoHS & no Sb/Br) - please check <http://www.ti.com/productcontent> for the latest availability information and additional product content details.

TBD: The Pb-Free/Green conversion plan has not been defined.

Pb-Free (RoHS): TI's terms "Lead-Free" or "Pb-Free" mean semiconductor products that are compatible with the current RoHS requirements for all 6 substances, including the requirement that lead not exceed 0.1% by weight in homogeneous materials. Where designed to be soldered at high temperatures, TI Pb-Free products are suitable for use in specified lead-free processes.

Pb-Free (RoHS Exempt): This component has a RoHS exemption for either 1) lead-based flip-chip solder bumps used between the die and package, or 2) lead-based die adhesive used between the die and leadframe. The component is otherwise considered Pb-Free (RoHS compatible) as defined above.

Green (RoHS & no Sb/Br): TI defines "Green" to mean Pb-Free (RoHS compatible), and free of Bromine (Br) and Antimony (Sb) based flame retardants (Br or Sb do not exceed 0.1% by weight in homogeneous material)

⁽³⁾ MSL, Peak Temp. -- The Moisture Sensitivity Level rating according to the JEDEC industry standard classifications, and peak solder temperature.

Important Information and Disclaimer:The information provided on this page represents TI's knowledge and belief as of the date that it is provided. TI bases its knowledge and belief on information provided by third parties, and makes no representation or warranty as to the accuracy of such information. Efforts are underway to better integrate information from third parties. TI has taken and continues to take reasonable steps to provide representative and accurate information but may not have conducted destructive testing or chemical analysis on incoming materials and chemicals. TI and TI suppliers consider certain information to be proprietary, and thus CAS numbers and other limited information may not be available for release.

In no event shall TI's liability arising out of such information exceed the total purchase price of the TI part(s) at issue in this document sold by TI to Customer on an annual basis.

P (R-PDIP-T8)

PLASTIC DUAL-IN-LINE



- NOTES: A. All linear dimensions are in inches (millimeters).
 B. This drawing is subject to change without notice.
 C. Falls within JEDEC MS-001

For the latest package information, go to http://www.ti.com/sc/docs/package/pkg_info.htm



IMPORTANT NOTICE

Texas Instruments Incorporated and its subsidiaries (TI) reserve the right to make corrections, modifications, enhancements, improvements, and other changes to its products and services at any time and to discontinue any product or service without notice. Customers should obtain the latest relevant information before placing orders and should verify that such information is current and complete. All products are sold subject to TI's terms and conditions of sale supplied at the time of order acknowledgment.

TI warrants performance of its hardware products to the specifications applicable at the time of sale in accordance with TI's standard warranty. Testing and other quality control techniques are used to the extent TI deems necessary to support this warranty. Except where mandated by government requirements, testing of all parameters of each product is not necessarily performed.

TI assumes no liability for applications assistance or customer product design. Customers are responsible for their products and applications using TI components. To minimize the risks associated with customer products and applications, customers should provide adequate design and operating safeguards.

TI does not warrant or represent that any license, either express or implied, is granted under any TI patent right, copyright, mask work right, or other TI intellectual property right relating to any combination, machine, or process in which TI products or services are used. Information published by TI regarding third-party products or services does not constitute a license from TI to use such products or services or a warranty or endorsement thereof. Use of such information may require a license from a third party under the patents or other intellectual property of the third party, or a license from TI under the patents or other intellectual property of TI.

Reproduction of information in TI data books or data sheets is permissible only if reproduction is without alteration and is accompanied by all associated warranties, conditions, limitations, and notices. Reproduction of this information with alteration is an unfair and deceptive business practice. TI is not responsible or liable for such altered documentation.

Resale of TI products or services with statements different from or beyond the parameters stated by TI for that product or service voids all express and any implied warranties for the associated TI product or service and is an unfair and deceptive business practice. TI is not responsible or liable for any such statements.

Following are URLs where you can obtain information on other Texas Instruments products and application solutions:

Products		Applications	
Amplifiers	amplifier.ti.com	Audio	www.ti.com/audio
Data Converters	dataconverter.ti.com	Automotive	www.ti.com/automotive
DSP	dsp.ti.com	Broadband	www.ti.com/broadband
Interface	interface.ti.com	Digital Control	www.ti.com/digitalcontrol
Logic	logic.ti.com	Military	www.ti.com/military
Power Mgmt	power.ti.com	Optical Networking	www.ti.com/opticalnetwork
Microcontrollers	microcontroller.ti.com	Security	www.ti.com/security
		Telephony	www.ti.com/telephony
		Video & Imaging	www.ti.com/video
		Wireless	www.ti.com/wireless

Mailing Address: Texas Instruments
Post Office Box 655303 Dallas, Texas 75265

Copyright © 2006, Texas Instruments Incorporated